

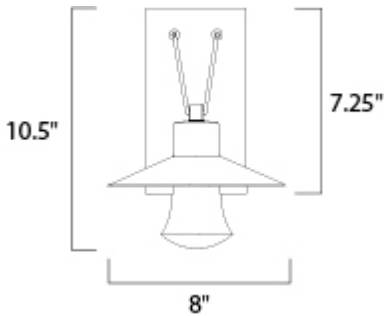

PRODUCT DESCRIPTION

Conical shades finished in Architectural Bronze appear to be suspended by its stainless steel cable. Concealed inside these shades is a high powered COB LED which shines into a heavy Clear glass font. The bottom of these fonts have an additional thickness of glass for better light distribution and lighting effect.



MEASUREMENTS

DIMENSION : 8" W x 10.5" H x 9.25" Ext
 BACK PLATE : 4.25" W x 7.25" H x 5.75" HCO
 HANGING WEIGHT : 2.64 lb

LAMPING

INPUT VOLTAGE : 120V
 LUMENS : 420 Rated (315 Del.)
 BULB : 1 x 6W LED PCB Integrated , 6W Total
 BULB INCLUDED : (Integrated)
 DIMMABLE : No
 CRI : 90+ CRI
 COLOR_TEMP : 3000K

FINISHES OPTION

-  Architectural Bronze (ABZ)
-  Brushed Aluminum (AL)

GLASS

Clear CL

MATERIAL

Die Cast Aluminum, Glass

RATINGS

cETLus
 Wet Location



ADDITIONAL

RATED LIFE 40000 Hours
 OPERATING TEMPERATURE:
 -20°C (-4°F), 40°C (104°F)

Always consult a qualified electrician before installing any lighting product.



WESTERN DISTRIBUTION CENTER (HEADQUARTER)
 253 NORTH VINELAND AVE | CITY OF INDUSTRY, CA 91746

EASTERN DISTRIBUTION CENTER
 101 GARDNER PARK | PEACHTREE CITY, GA 30269

P. 626.956.4200 | F. 626.956.4225 | maximlighting.com