

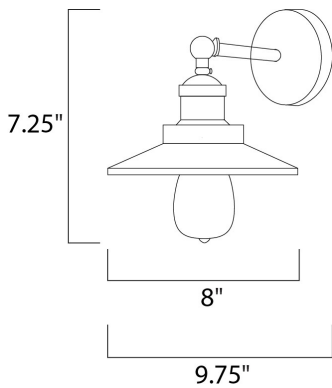

PRODUCT DESCRIPTION

Small pendants reminiscent of yesteryear are available in your choice of Bronze, Antique Copper, Satin Nickel, and Polished Nickel. In addition to the numerous metal shades, glass shades in Clear, Mirror Smoke, and Satin White are also offered. The optional Antique Replica light bulb adds to the authentic look.



MEASUREMENTS

DIMENSION : 8" W x 7.25" H x 9.75" Ext
 MAX OAH : 4.5" W x 4.5" H
 HANGING WEIGHT : 3.6 lb

LAMPING

INPUT VOLTAGE : 120V
 BULB : 1 x 60W Incandescent E26 Medium , 60W Total
 BULB INCLUDED : (Included)
 DIMMABLE : Yes

FINISHES OPTION

-  Antique Copper (ACP)
-  Bronze (BZ)
-  Satin Nickel (SN)

MATERIAL

Steel, Aluminum

RATINGS

cULus
 Dry Location



ADDITIONAL

INSTALL UP/DOWN: Up/Down
 OPERATING TEMPERATURE:
 -20°C (-4°F), 40°C (104°F)

Always consult a qualified electrician before installing any lighting product.



WESTERN DISTRIBUTION CENTER (HEADQUARTER)
 253 NORTH VINELAND AVE | CITY OF INDUSTRY, CA 91746

EASTERN DISTRIBUTION CENTER
 101 GARDNER PARK | PEACHTREE CITY, GA 30269

P. 626.956.4200 | F. 626.956.4225 | maximlighting.com