

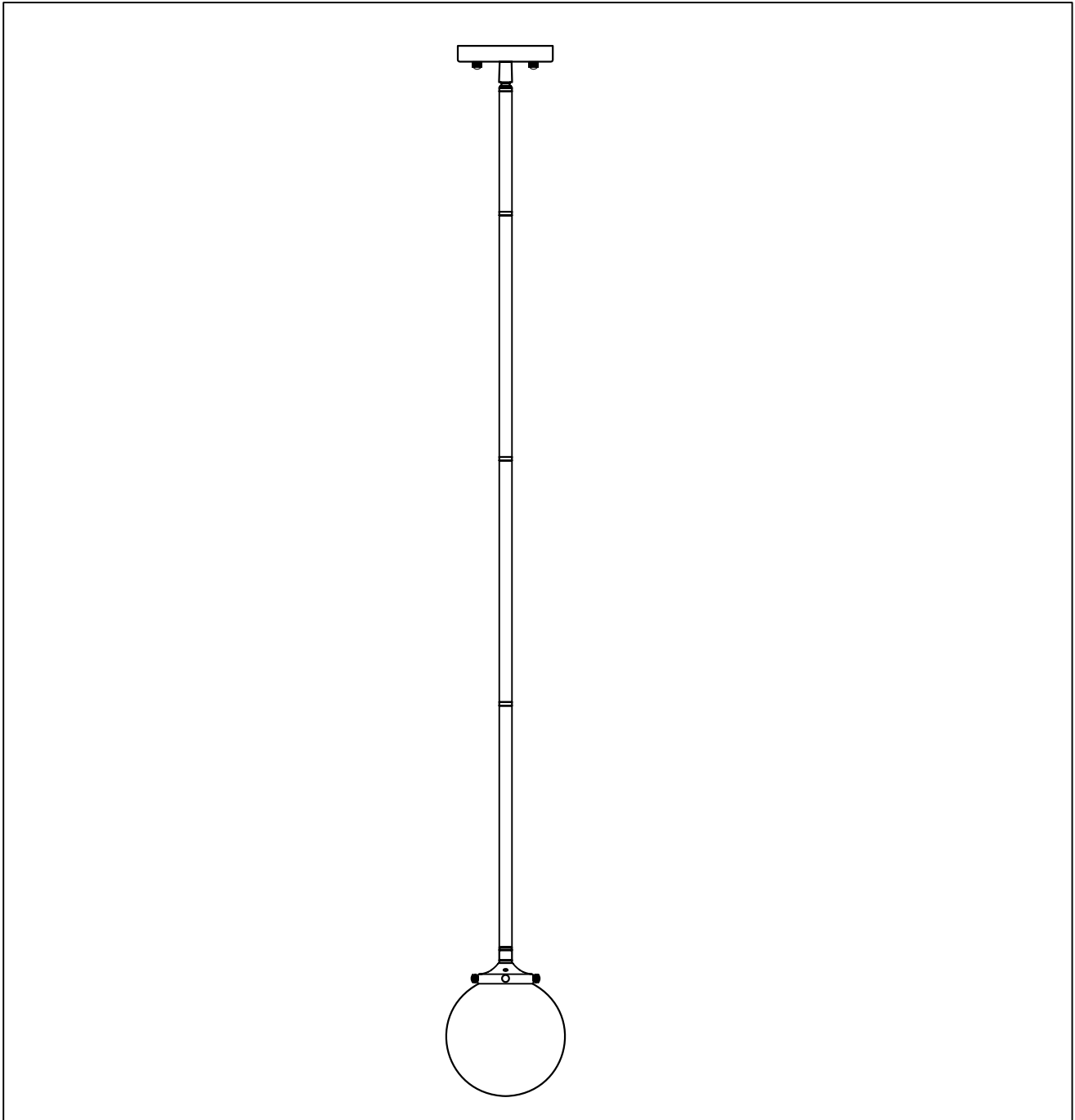

PRODUCT NAME: Atom
ITEM NUMBER: 94720

Please consult your electrician for hanging fixture and wiring.



Bulb(not included) E12 1 x MAX 40W

IMPORTANT: Turn off the power at the main fuse of circuit breaker box before starting installation

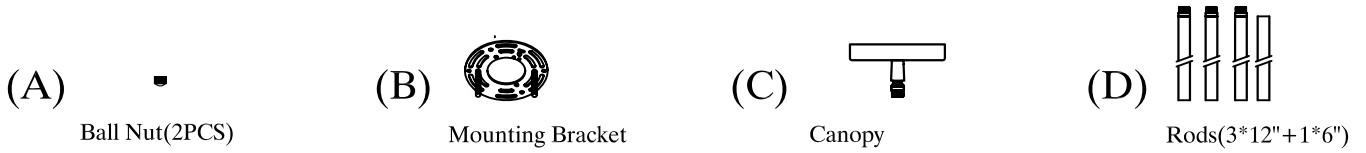

Locate all hardware & components before discarding packaging

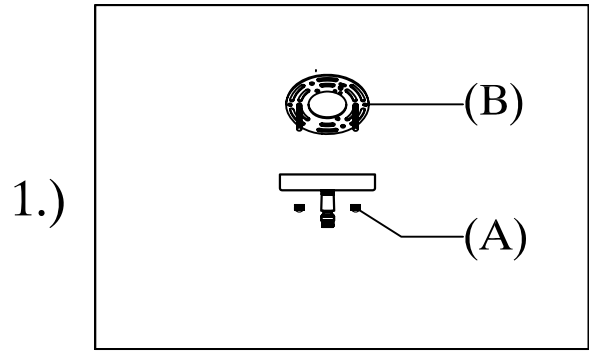
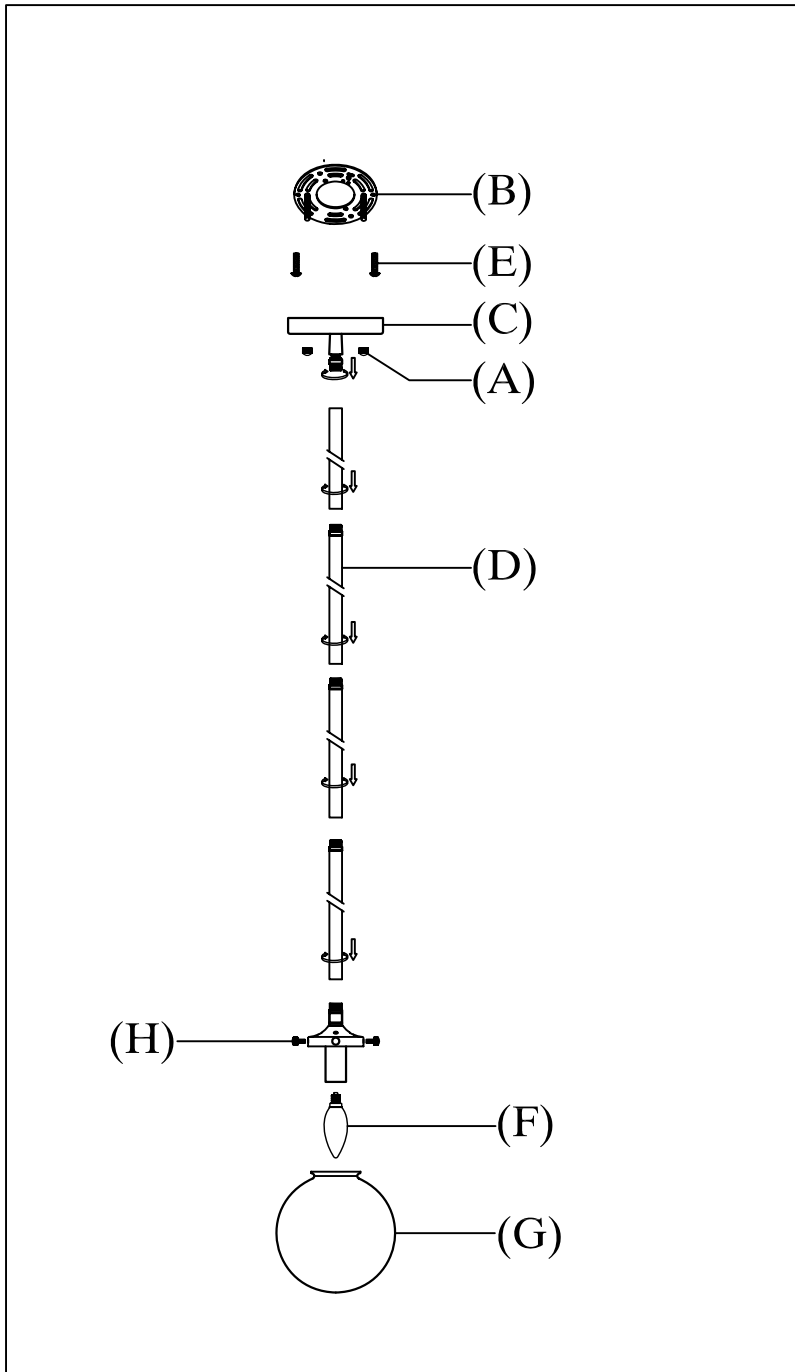

step1: Remove mounting bracket (B) from fixture and install to electrical box

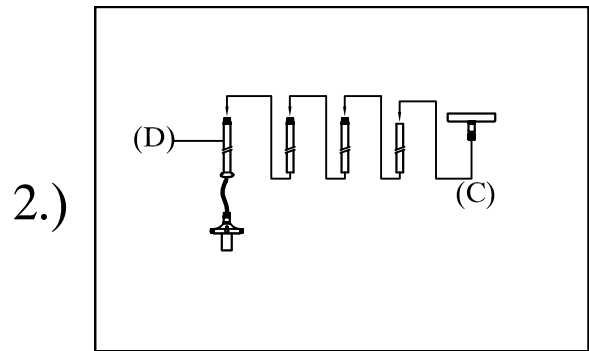

step2: Carefully remove packaging from fixture. Run wire through stems (D) and combine stem lengths to meet desired mounting height. Then attach canopy (C) to fixture.

Cleaning & Care:

Clean with soft cloth and a mild detergent.
Do not use abrasive cleaner.

IMPORTANT: Turn off the power at the main fuse of circuit breaker box before starting installation

(E) 
Mounting Screws(2pcs)

(F) 
Bulb(Not Included)

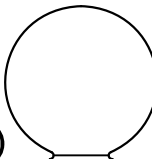
(G) 
Glass Shade

(H) 
Lock Screws(4pcs)

Locate all hardware & components before discarding packaging

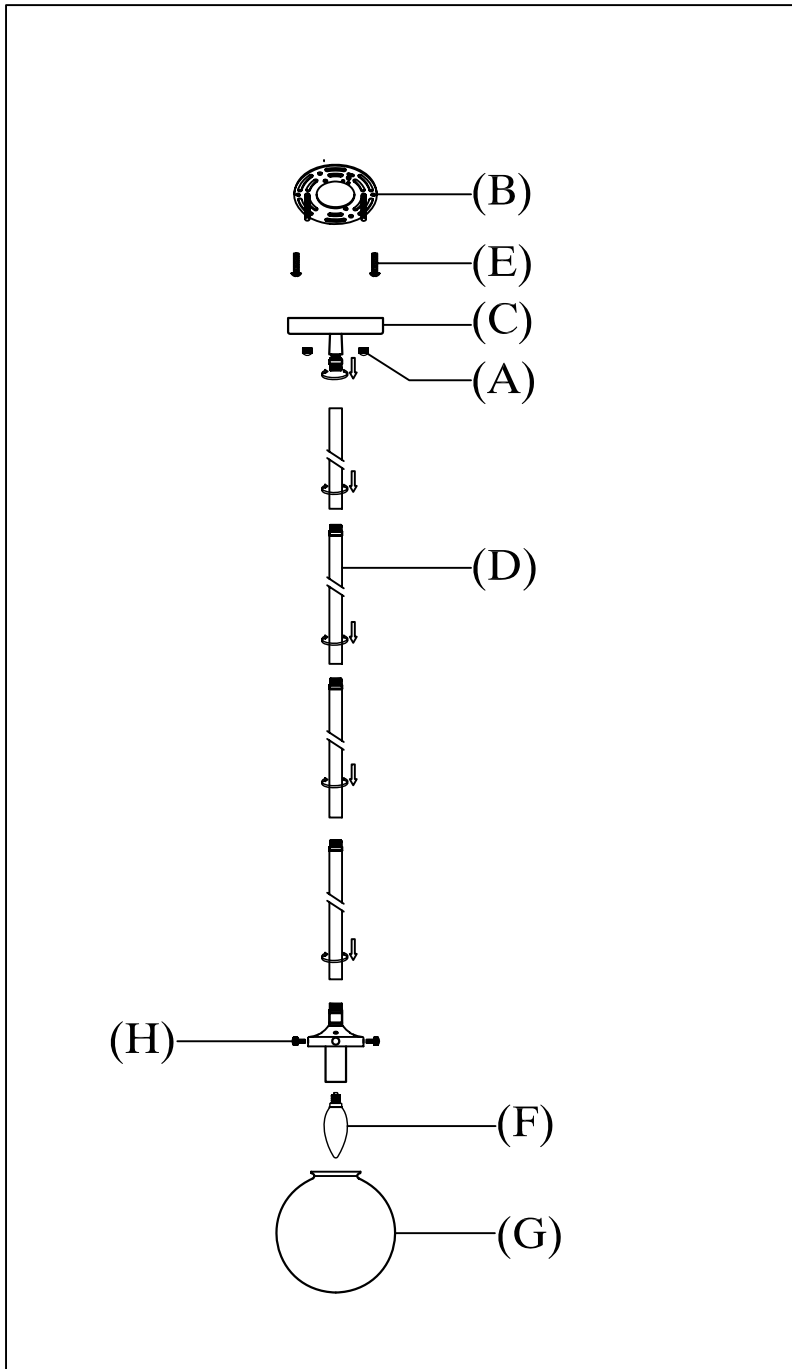

3.)

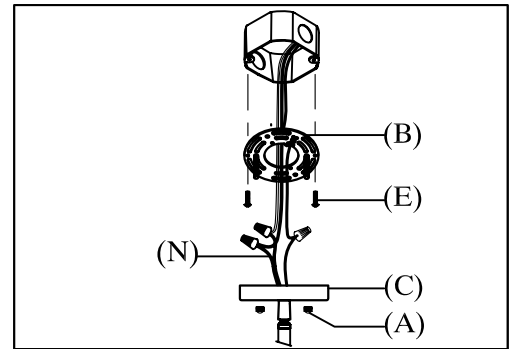

step3: Wire fixture to wires in outlet box. Copper wire in canopy is for grounding. Install canopy (C) to mounting bracket(B) using ball nuts (A) to secure.

4.)

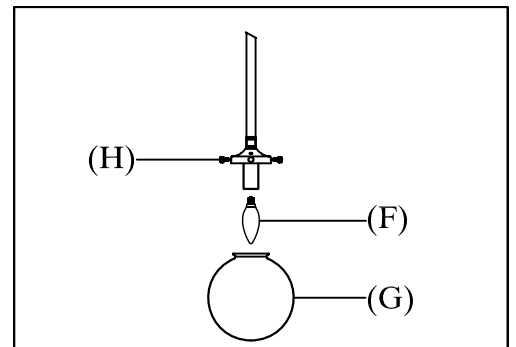

step4: Loosen the lock screws (H). Install E12 bulb(F) and attach glass (G). Secure glass (G) by tightening lock screws (H).

Cleaning & Care:

Clean with soft cloth and a mild detergent.
Do not use abrasive cleaner.

MADE IN CHINA

Page 3 of (3)