

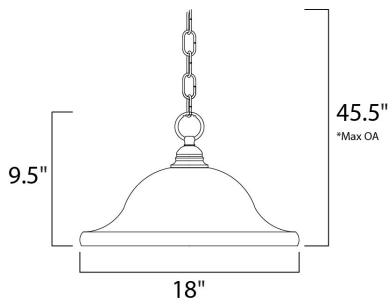

PRODUCT DESCRIPTION

Maxim Lighting's commitment to both the residential lighting and the home building industries will assure you a product line focused on your lighting needs. With Maxim Lighting you will find quality product that is well designed, well priced and readily available.



*max overall height

MEASUREMENTS

DIMENSION : 18" W x 9.5" H
 HANGING WEIGHT : 6.83 lb

LAMPING

LUMENS : 1,150 Rated
 BULB : 1 x 100W Incandescent MB , 0W Total
 BULB INCLUDED : (Not Included)
 DIMMABLE :
 COLOR_TEMP : 2700K

FINISHES OPTION

-  Acorn
-  Country Stone
-  Pewter
-  Polished Brass
-  Satin Nickel

GLASS

Marble MR

MATERIAL

Iron

RATINGS

Dry Location



ADDITIONAL

RATED LIFE 2500 Hours
 OPERATING TEMPERATURE:
 -20°C (-4°F), 40°C (104°F)

Always consult a qualified electrician before installing any lighting product.



WESTERN DISTRIBUTION CENTER (HEADQUARTER)
 253 NORTH VINELAND AVE | CITY OF INDUSTRY, CA 91746

EASTERN DISTRIBUTION CENTER
 4200 SHIRLEY DR. | ATLANTA, GA 30336

P. 626.956.4200 | F. 626.956.4225 | maximlighting.com