

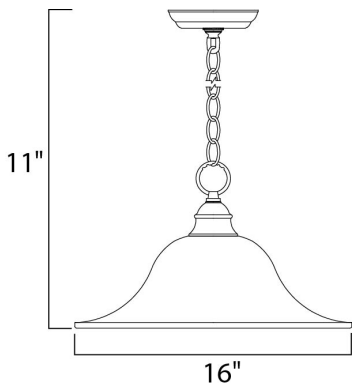

**PRODUCT DESCRIPTION**

Maxim Lighting's commitment to both the residential lighting and the home building industries will assure you a product line focused on your lighting needs. With Maxim Lighting you will find quality product that is well designed, well priced and readily available.









**MEASUREMENTS**

DIMENSION : 16" L x 16" W x 11" H  
 HANGING WEIGHT : 5.8 lb

**LAMPING**

INPUT VOLTAGE : 120V  
 LUMENS : 1,150 Rated  
 BULB : 1 x 60W Incandescent E26 Medium , 60W Total  
 BULB INCLUDED : (Not Included)  
 DIMMABLE : Yes

**FINISHES OPTION**

-  Acorn
-  Country Stone
-  Oil Rubbed Bronze
-  Pewter
-  Polished Brass
-  Satin Nickel

**GLASS**

Wilshire WS

**MATERIAL**

Steel + Glass

**RATINGS**

cETLus  
 Dry Location



**ADDITIONAL**

ADJUSTABLE  
 RATED LIFE 2500 Hours  
 OPERATING TEMPERATURE:  
 -20°C (-4°F), 40°C (104°F)

Always consult a qualified electrician before installing any lighting product.



**WESTERN DISTRIBUTION CENTER (HEADQUARTER)**  
253 NORTH VINELAND AVE | CITY OF INDUSTRY, CA 91746

**EASTERN DISTRIBUTION CENTER**  
4200 SHIRLEY DR. | ATLANTA, GA 30336

P. 626.956.4200 | F. 626.956.4225 | [maximlighting.com](http://maximlighting.com)