

**PRODUCT DESCRIPTION**

Maxim Lighting's commitment to both the residential lighting and the home building industries will assure you a product line focused on your lighting needs. With Maxim Lighting you will find quality product that is well designed, well priced and readily a

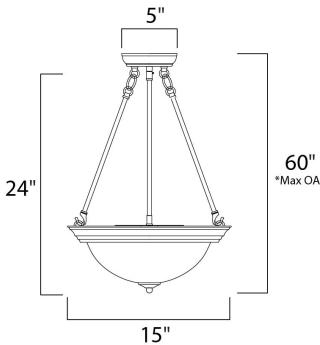

\*max overall height







**MEASUREMENTS**

DIMENSION : 15" W x 24" H  
 HANGING WEIGHT : 6.2 lb

**LAMPING**

LUMENS : 3,450 Rated  
 BULB : 3 x 60W Incandescent E26 Medium , 180W Total  
 BULB INCLUDED : (Not Included)  
 DIMMABLE : Yes  
 COLOR\_TEMP : 2700K

**FINISHES OPTION**

-  Acorn
-  Country Stone
-  Light Gold
-  Oil Rubbed Bronze
-  Pewter
-  Polished Brass
-  Satin Nickel

**GLASS**

Marble MR

**MATERIAL**

Glass + Steel

**RATINGS**

cETLus  
 Dry Location



**ADDITIONAL**

RATED LIFE 2500 Hours  
 OPERATING TEMPERATURE:  
 -20°C (-4°F), 40°C (104°F)

Always consult a qualified electrician before installing any lighting product.



**WESTERN DISTRIBUTION CENTER (HEADQUARTER)**  
253 NORTH VINELAND AVE | CITY OF INDUSTRY, CA 91746

**EASTERN DISTRIBUTION CENTER**  
4200 SHIRLEY DR. | ATLANTA, GA 30336

P. 626.956.4200 | F. 626.956.4225 | [maximlighting.com](http://maximlighting.com)