

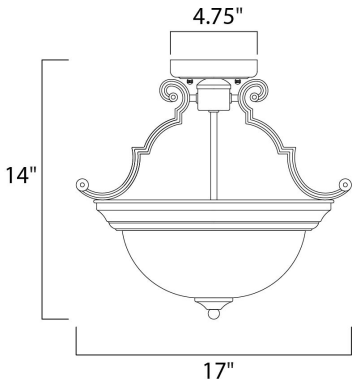

PRODUCT DESCRIPTION

Maxim Lighting's commitment to both the residential lighting and the home building industries will assure you a product line focused on your lighting needs. With Maxim Lighting you will find quality product that is well designed, well priced and readily a











MEASUREMENTS

DIMENSION : 17" W x 14" H
 HANGING WEIGHT : 6.17 lb

LAMPING

LUMENS : 3,450 Rated
 BULB : 3 x 100W Incandescent MB , 300W Total
 BULB INCLUDED : (Not Included)
 DIMMABLE : Yes
 COLOR_TEMP : 2700K

FINISHES OPTION

-  Acorn
-  Country Stone
-  Light Gold
-  Oil Rubbed Bronze
-  Pewter
-  Polished Brass
-  Satin Nickel
-  White

GLASS

Marble MR

MATERIAL

Glass + Steel

RATINGS

cETLus
 Dry Location



ADDITIONAL

RATED LIFE 2500 Hours
 OPERATING TEMPERATURE:
 -20°C (-4°F), 40°C (104°F)

Always consult a qualified electrician before installing any lighting product.



WESTERN DISTRIBUTION CENTER (HEADQUARTER)
253 NORTH VINELAND AVE | CITY OF INDUSTRY, CA 91746

EASTERN DISTRIBUTION CENTER
4200 SHIRLEY DR. | ATLANTA, GA 30336

P. 626.956.4200 | F. 626.956.4225 | maximlighting.com