

**PRODUCT DESCRIPTION**

Maxim Lighting's commitment to both the residential lighting and the home building industries will assure you a product line focused on your lighting needs. With Maxim Lighting you will find quality product that is well designed, well priced and readily available.

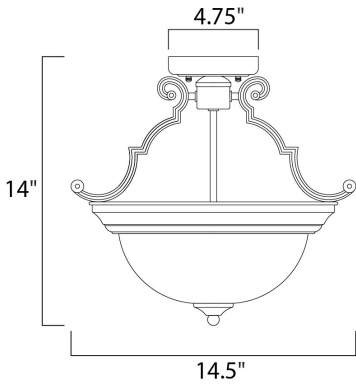











**MEASUREMENTS**

DIMENSION : 14.75" W x 14" H  
 HANGING WEIGHT : 4.74 lb

**LAMPING**

LUMENS : 2,300 Rated  
 BULB : 2 x 100W Incandescent MB , 0W Total  
 BULB INCLUDED : (Not Included)  
 DIMMABLE :  
 COLOR\_TEMP : 2700K

**FINISHES OPTION**

-  Acor
-  Country Stone
-  Filbert
-  Navaho White
-  Oil Rubbed Bronze
-  Pewter
-  Polished Brass
-  Satin Nickel
-  Textured White
-  White

**GLASS**

Frosted FT

**MATERIAL**

Iron, Glass, Zinc

**RATINGS**

Dry Location



**ADDITIONAL**

RATED LIFE 2500 Hours  
 OPERATING TEMPERATURE:  
 -20°C (-4°F), 40°C (104°F)



**WESTERN DISTRIBUTION CENTER (HEADQUARTER)**  
253 NORTH VINELAND AVE | CITY OF INDUSTRY, CA 91746

**EASTERN DISTRIBUTION CENTER**  
4200 SHIRLEY DR. | ATLANTA, GA 30336

P. 626.956.4200 | F. 626.956.4225 | [maximlighting.com](http://maximlighting.com)