

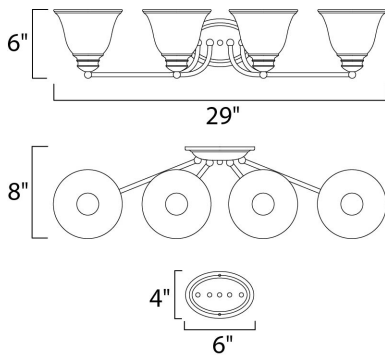

**PRODUCT DESCRIPTION**

Maxim Lighting's commitment to both the residential lighting and the home building industries will assure you a product line focused on your basic lighting needs. With the Malaga collection you will find quality lighting that is well designed, well priced and readily available.









**MEASUREMENTS**

DIMENSION : 29" W x 6" H x 8" Ext  
 BACK PLATE : 6.25" W x 4.25" H  
 HANGING WEIGHT : 5.06 lb

**LAMPING**

INPUT VOLTAGE : 120V  
 LUMENS : 4,600 Rated  
 BULB : 4 x 100W Incandescent MB , 400W Total  
 BULB INCLUDED : (Not Included)  
 DIMMABLE : Yes  
 COLOR\_TEMP : 2700K  
 LIGHTING\_DIRECTION : Both

**FINISHES OPTION**

-  Acorn
-  Country Stone
-  Oil Rubbed Bronze
-  Pewter
-  Polished Brass
-  Satin Nickel
-  White Gold

**GLASS**

Marble MR

**MATERIAL**

Glass + Steel

**RATINGS**

cETLus  
 Damp Location



**ADDITIONAL**

INSTALL UP/DOWN: Both  
 RATED LIFE 2500 Hours  
 OPERATING TEMPERATURE:  
 -20°C (-4°F), 40°C (104°F)

Always consult a qualified electrician before installing any lighting product.



**WESTERN DISTRIBUTION CENTER (HEADQUARTER)**  
253 NORTH VINELAND AVE | CITY OF INDUSTRY, CA 91746

**EASTERN DISTRIBUTION CENTER**  
4200 SHIRLEY DR. | ATLANTA, GA 30336

P. 626.956.4200 | F. 626.956.4225 | [maximlighting.com](http://maximlighting.com)