

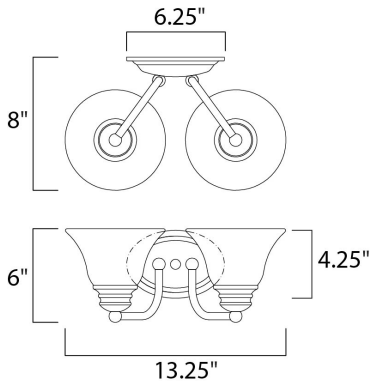

PRODUCT DESCRIPTION

Maxim Lighting's commitment to both the residential lighting and the home building industries will assure you a product line focused on your basic lighting needs. With the Malaga collection you will find quality lighting that is well designed, well priced and readily available.









MEASUREMENTS

DIMENSION : 13.25" W x 6" H x 8" Ext
 BACK PLATE : 6.25" W x 4.25" H x 2.21" HCO
 HANGING WEIGHT : 2.4 lb

LAMPING

INPUT VOLTAGE : 120V
 LUMENS : 2,300 Rated
 BULB : 2 x 100W Incandescent MB , 200W Total
 BULB INCLUDED : (Not Included)
 DIMMABLE : Yes
 COLOR_TEMP : 2700K
 LIGHTING_DIRECTION : Both

FINISHES OPTION

-  Acorn
-  Country Stone
-  Oil Rubbed Bronze
-  Pewter
-  Polished Brass
-  Satin Nickel
- White Gold

GLASS

Marble MR

MATERIAL

Glass + Steel

RATINGS

cETLus
 Damp Location



ADDITIONAL

INSTALL UP/DOWN: Both
 RATED LIFE 2500 Hours
 OPERATING TEMPERATURE:
 -20°C (-4°F), 40°C (104°F)

Always consult a qualified electrician before installing any lighting product.



WESTERN DISTRIBUTION CENTER (HEADQUARTER)
253 NORTH VINELAND AVE | CITY OF INDUSTRY, CA 91746

EASTERN DISTRIBUTION CENTER
4200 SHIRLEY DR. | ATLANTA, GA 30336

P. 626.956.4200 | F. 626.956.4225 | maximlighting.com