

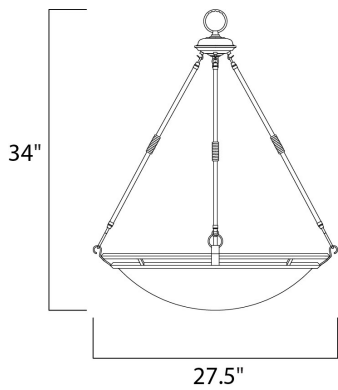

**PRODUCT DESCRIPTION**

Clean lines are simply stated in this collection. Offered in Marble glass with your choice of Bronze or Pewter finishes.



**MEASUREMENTS**

DIMENSION : 27.5" L x 27.5" W x 30.5" H  
 HANGING WEIGHT : 11.9 lb

**LAMPING**

INPUT VOLTAGE : 120V  
 LUMENS : 6,900 Rated  
 BULB : 6 x 60W Incandescent E26 Medium , 360W Total  
 BULB INCLUDED : (Not Included)  
 DIMMABLE : Yes

**FINISHES OPTION**

-  Bronze
-  Pewter
-  Polished Chrome

**GLASS**

Marble MR

**MATERIAL**

Steel

**RATINGS**

cULus  
 Dry Location



**ADDITIONAL**

ADJUSTABLE  
 RATED LIFE 2500 Hours  
 OPERATING TEMPERATURE:  
 -20°C (-4°F), 40°C (104°F)

Always consult a qualified electrician before installing any lighting product.



**WESTERN DISTRIBUTION CENTER (HEADQUARTER)**  
 253 NORTH VINELAND AVE | CITY OF INDUSTRY, CA 91746  
**EASTERN DISTRIBUTION CENTER**  
 4200 SHIRLEY DR. | ATLANTA, GA 30336  
 P. 626.956.4200 | F. 626.956.4225 | maximlighting.com