

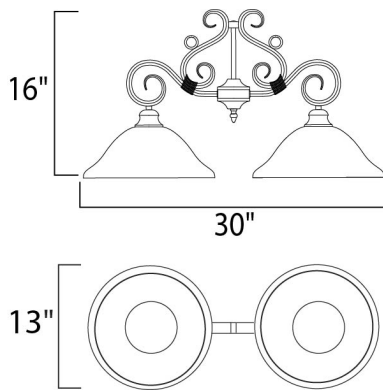

PRODUCT DESCRIPTION

Simple, elegant designs offered in a variety of our most popular finishes. Choose from Acorn, Country Stone, Pewter and Kentucky Bronze. Glass options are Marble and Wilshire.



MEASUREMENTS

DIMENSION : 30" L x 13" W x 16" H
 MAX OAH : 88" OAH
 CANOPY : 4.5" W x 0.75" H x 9" L
 HANGING WEIGHT : 10.58 lb

LAMPING

LUMENS : 2,300 Rated
 BULB : 2 x 100W Incandescent MB , 200W Total
 BULB INCLUDED : (Not Included)
 DIMMABLE : Yes
 COLOR_TEMP : 2700K

FINISHES OPTION

-  Acorn
-  Country Stone
-  Kentucky Bronze
-  Pewter

GLASS

Marble MR

MATERIAL

Steel

RATINGS

cULus
 Dry Location



ADDITIONAL

RATED LIFE 2500 Hours
 OPERATING TEMPERATURE:
 -20°C (-4°F), 40°C (104°F)

Always consult a qualified electrician before installing any lighting product.



WESTERN DISTRIBUTION CENTER (HEADQUARTER)

253 NORTH VINELAND AVE | CITY OF INDUSTRY, CA 91746

EASTERN DISTRIBUTION CENTER

4200 SHIRLEY DR. | ATLANTA, GA 30336

P. 626.956.4200 | F. 626.956.4225 | maximlighting.com