

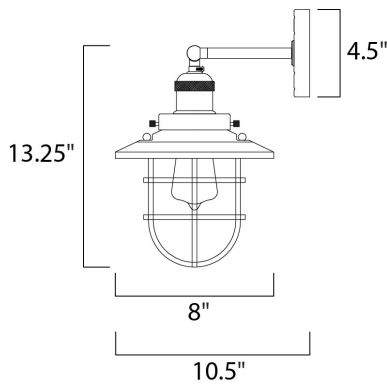

**PRODUCT DESCRIPTION**

Small pendants reminiscent of yesteryear are available in your choice of Bronze, Antique Copper, Satin Nickel, and Polished Nickel. In addition to the numerous metal shades, glass shades in Clear, Mirror Smoke, and Satin White are also offered. The optional Antique Replica light bulb adds to the authentic look.



**MEASUREMENTS**

DIMENSION : 8" W x 13.25" H x 10.5" Ext  
 MAX OAH : 4.5" W x 4.5" H  
 HANGING WEIGHT : 2.8 lb

**LAMPING**

INPUT VOLTAGE : 120V  
 LUMENS : 0 Rated  
 BULB : 1 x 60W Incandescent E26 Medium , 60W Total  
 BULB INCLUDED : (Not Included)  
 DIMMABLE : Yes

**FINISHES OPTION**

-  Antique Copper
-  Bronze
-  Polished Nickel
-  Satin Nickel

**MATERIAL**

Steel + Aluminum

**RATINGS**

cULus  
 Dry Location



**ADDITIONAL**

INSTALL UP/DOWN: Up/Dn  
 OPERATING TEMPERATURE:  
 -20°C (-4°F), 40°C (104°F)

Always consult a qualified electrician before installing any lighting product.



**WESTERN DISTRIBUTION CENTER (HEADQUARTER)**  
 253 NORTH VINELAND AVE | CITY OF INDUSTRY, CA 91746

**EASTERN DISTRIBUTION CENTER**  
 4200 SHIRLEY DR. | ATLANTA, GA 30336

P. 626.956.4200 | F. 626.956.4225 | maximlighting.com