

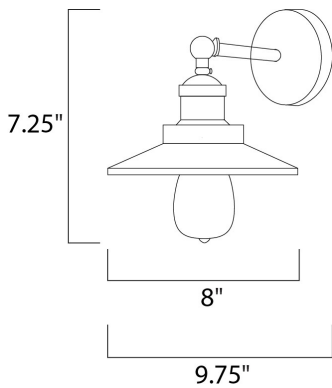

PRODUCT DESCRIPTION

Small pendants reminiscent of yesteryear are available in your choice of Bronze, Antique Copper, Satin Nickel, and Polished Nickel. In addition to the numerous metal shades, glass shades in Clear, Mirror Smoke, and Satin White are also offered. The optional Antique Replica light bulb adds to the authentic look.



MEASUREMENTS

DIMENSION : 8" W x 7.25" H x 9.75" Ext
 MAX OAH : 4.5" W x 4.5" H
 HANGING WEIGHT : 3.6 lb

LAMPING

INPUT VOLTAGE : 120V
 LUMENS : 0 Rated
 BULB : 1 x 60W Incandescent MB , 60W Total
 BULB INCLUDED : (Not Included)
 DIMMABLE : Yes

FINISHES OPTION

-  Antique Copper
-  Bronze
-  Polished Nickel
-  Satin Nickel

MATERIAL

Steel + Aluminum

RATINGS

cULus
 Dry Location



ADDITIONAL

INSTALL UP/DOWN: Up/Dn
 OPERATING TEMPERATURE:
 -20°C (-4°F), 40°C (104°F)

Always consult a qualified electrician before installing any lighting product.



WESTERN DISTRIBUTION CENTER (HEADQUARTER)
 253 NORTH VINELAND AVE | CITY OF INDUSTRY, CA 91746
EASTERN DISTRIBUTION CENTER
 4200 SHIRLEY DR. | ATLANTA, GA 30336
 P. 626.956.4200 | F. 626.956.4225 | maximlighting.com