

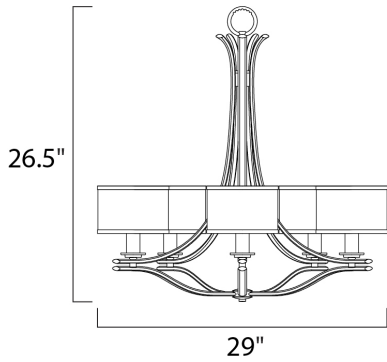

PRODUCT DESCRIPTION

Orion collection's sweeping arms formed from oval-shaped Satin Nickel add stark contrast to the charcoal-colored, sheer fabric shades with Satin White interior glass. This contemporary collection works well in both modern and transitional interiors.



MEASUREMENTS

DIMENSION : 29" W x 26.5" H
 HANGING WEIGHT : 9.44 lb

LAMPING

INPUT VOLTAGE : 120V
 LUMENS : 5,750 Rated
 BULB : 5 x 60W Incandescent E26 Medium , 300W Total
 BULB INCLUDED : (Not Included)
 DIMMABLE : Yes

FINISHES OPTION

 Satin Nickel

GLASS

Satin White SW

MATERIAL

Steel + Fabric + Glass

RATINGS

cETLus
 Dry Location



ADDITIONAL

RATED LIFE 2500 Hours
 OPERATING TEMPERATURE:
 -20°C (-4°F), 40°C (104°F)

Always consult a qualified electrician before installing any lighting product.



WESTERN DISTRIBUTION CENTER (HEADQUARTER)
 253 NORTH VINELAND AVE | CITY OF INDUSTRY, CA 91746

EASTERN DISTRIBUTION CENTER
 4200 SHIRLEY DR. | ATLANTA, GA 30336

P. 626.956.4200 | F. 626.956.4225 | maximlighting.com