

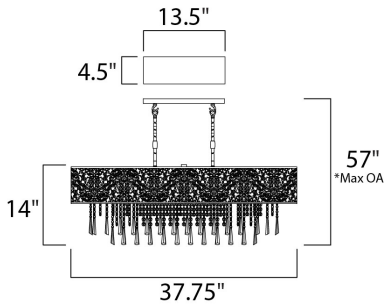

PRODUCT DESCRIPTION

The Rapture Collection's delicate pattern in Satin Nickel stainless steel creates a silhouette against the inner fabric shade available in your choice of White, Black or Red. The shimmer of crystal adds a touch of elegance to this transitional style.



*max overall height

MEASUREMENTS

- DIMENSION : 37.75" L x 8.25" W x 14" H
- MAX OAH : 57" OAH
- CANOPY : 4.53" W x 0.35" H x 13.58" L
- HANGING WEIGHT : 18.88 lb

LAMPING

- LUMENS : 5,250 Rated
- BULB : 7 x 40W Xenon G9 , 280W Total
- BULB INCLUDED : (Included)
- DIMMABLE : Yes
- COLOR_TEMP : 2900K

FINISHES OPTION

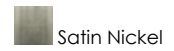

MATERIAL

Stainless Steel + Fabric + Crystal

RATINGS

cETLus
Dry Location



ADDITIONAL

SLOPE: 120
RATED LIFE 2000 Hours
OPERATING TEMPERATURE:
-20°C (-4°F), 40°C (104°F)

Always consult a qualified electrician before installing any lighting product.



WESTERN DISTRIBUTION CENTER (HEADQUARTER)
253 NORTH VINELAND AVE | CITY OF INDUSTRY, CA 91746

EASTERN DISTRIBUTION CENTER
4200 SHIRLEY DR. | ATLANTA, GA 30336

P. 626.956.4200 | F. 626.956.4225 | maximlighting.com