

PRODUCT DESCRIPTION

Cubic collection's bold Clear crystal cubes are mounted on a solid metal frame finished in a mirror-like Polished Chrome. The inside of the crystal cubes are frosted to nicely diffuse the natural light created from the included xenon bulbs.

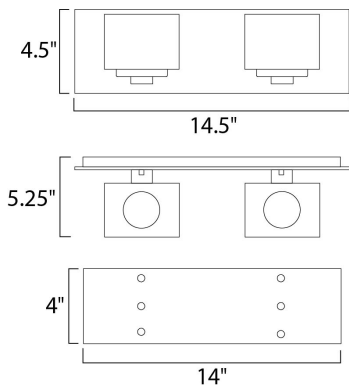

MEASUREMENTS

DIMENSION : 14.5" W x 4.5" H x 5.25" Ext
 BACK PLATE : 14.13" W x 4.13" H
 HANGING WEIGHT : 10.18 lb

LAMPING

INPUT VOLTAGE : 120V
 LUMENS : 1,600 Rated
 BULB : 2 x 40W Xenon G9 , 80W Total
 BULB INCLUDED : (Included)
 DIMMABLE : Yes
 COLOR_TEMP : 2900K

FINISHES OPTION



GLASS

Clear CL

MATERIAL

Metal, Crystal

RATINGS

cETLus
 Damp Location



ADDITIONAL

INSTALL UP/DOWN: Up
 RATED LIFE 2000 Hours
 OPERATING TEMPERATURE:
 -20°C (-4°F), 40°C (104°F)

Always consult a qualified electrician before installing any lighting product.



WESTERN DISTRIBUTION CENTER (HEADQUARTER)
 253 NORTH VINELAND AVE | CITY OF INDUSTRY, CA 91746

EASTERN DISTRIBUTION CENTER
 4200 SHIRLEY DR. | ATLANTA, GA 30336

P. 626.956.4200 | F. 626.956.4225 | maximlighting.com