

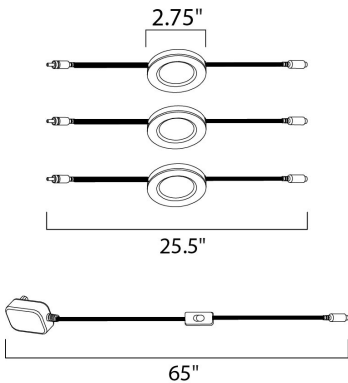

PRODUCT DESCRIPTION

Now our MX-LD-KIT discs are available in a convenient kit for the DIY customer. The kit includes three discs and a plug in driver with switch for fast and easy installation. These discs can be surface mounted or recessed. Die cast aluminum construction provides for durable construction and cool operation and are available in your choice of Bronze, White, or Aluminum.





MEASUREMENTS

DIMENSION : 2.75" W x 0.5" H
 HANGING WEIGHT : 0.55 lb

LAMPING

INPUT VOLTAGE : 24V
 LUMENS : 220 Rated
 BULB : 3 x 2.3W LED LED , 0W Total
 BULB INCLUDED : (Integrated)
 DIMMABLE : No
 CRI : 80+ CRI
 COLOR_TEMP : 3000K

FINISHES OPTION

-  Anodized Bronze (BRZ)
-  Brushed Aluminum (AL)
-  White (WT)

MATERIAL

Aluminum

RATINGS

Dry Location



ADDITIONAL

OPERATING TEMPERATURE:
 -20°C (-4°F), 40°C (104°F)

Always consult a qualified electrician before installing any lighting product.



WESTERN DISTRIBUTION CENTER (HEADQUARTER)
 253 NORTH VINELAND AVE | CITY OF INDUSTRY, CA 91746

EASTERN DISTRIBUTION CENTER
 101 GARDNER PARK | PEACHTREE CITY, GA 30269

P. 626.956.4200 | F. 626.956.4225 | maximlighting.com