

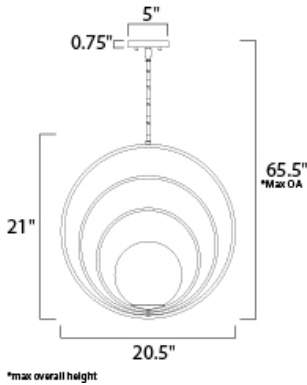

PRODUCT DESCRIPTION

Adjustable rings available in Polished Chrome or Satin Brass add dimension to this contemporary pendant design. Opal white glass softly diffuses light to complete the look.



MEASUREMENTS

- DIMENSION : 20.5" W x 21" H
- MAX OAH : 65.5" OAH
- CANOPY : 5" W x 0.75" H
- HANGING WEIGHT : 7.28 lb

LAMPING

- INPUT VOLTAGE : 120V
- BULB : 1 x 60W Incandescent E26 Medium , 60W Total
- BULB INCLUDED : (Not Included)
- DIMMABLE : Yes

FINISHES OPTION

- Polished Chrome (PC)
- Satin Brass (SBR)

GLASS

Satin White SW

MATERIAL

Steel, Glass

RATINGS

cULus
Dry Location



ADDITIONAL

ADJUSTABLE
SLOPE: 15
OPERATING TEMPERATURE:
-20°C (-4°F), 40°C (104°F)

Always consult a qualified electrician before installing any lighting product.



WESTERN DISTRIBUTION CENTER (HEADQUARTER)
253 NORTH VINELAND AVE | CITY OF INDUSTRY, CA 91746

EASTERN DISTRIBUTION CENTER
101 GARDNER PARK | PEACHTREE CITY, GA 30269

P. 626.956.4200 | F. 626.956.4225 | maximlighting.com