

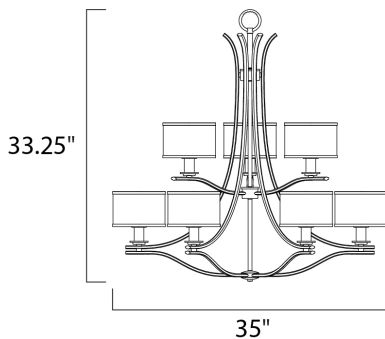

PRODUCT DESCRIPTION

Orion collection's sweeping arms formed from oval-shaped Satin Nickel add stark contrast to the charcoal-colored, sheer fabric shades with Satin White interior glass. This contemporary collection works well in both modern and transitional interiors.



MEASUREMENTS

DIMENSION : 35" W x 33.25" H

HANGING WEIGHT : 21.96 lb

LAMPING

INPUT VOLTAGE : 120V

BULB : 9 x 60W Incandescent E26 Medium , 540W Total

BULB INCLUDED : (Not Included)

DIMMABLE : Yes

FINISHES OPTION

 Satin Nickel (SN)

GLASS

Satin White SW

MATERIAL

Steel, Fabric, Glass

RATINGS

cETLus
Dry Location



ADDITIONAL

OPERATING TEMPERATURE:
-20°C (-4°F), 40°C (104°F)

Always consult a qualified electrician before installing any lighting product.



WESTERN DISTRIBUTION CENTER (HEADQUARTER)
253 NORTH VINELAND AVE | CITY OF INDUSTRY, CA 91746

EASTERN DISTRIBUTION CENTER
101 GARDNER PARK | PEACHTREE CITY, GA 30269

P. 626.956.4200 | F. 626.956.4225 | maximlighting.com