

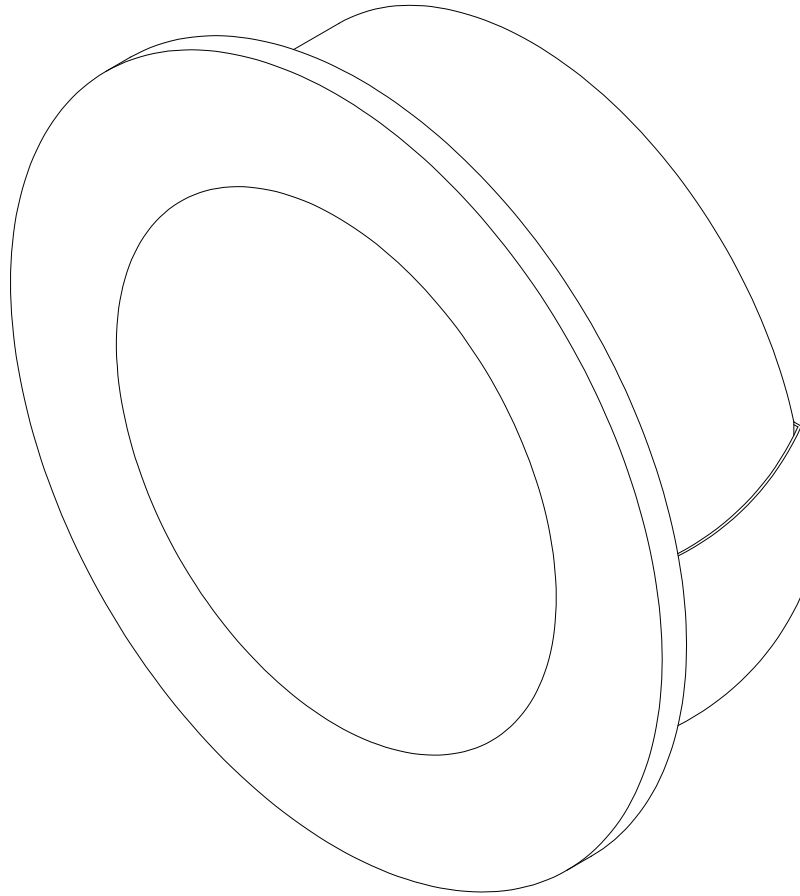

PRODUCT NAME: Path

ITEM NUMBER: 58006WT / 58006AL / 58006BZ

Please consult your electrician for hanging fixture and wiring.



To prevent water intrusion, caulk around back-plate where fixture meets the wall using outdoor silicone sealant. Leave a small gap at the bottom to allow moisture to exit.

IMPORTANT: Turn off the power at the main fuse or circuit breaker box before starting installation

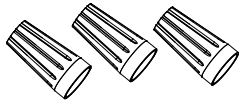

(A)
Wire Nuts (x3)

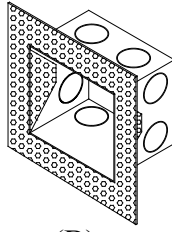

(B)
Mounting box

Locate all hardware & components before discarding packaging

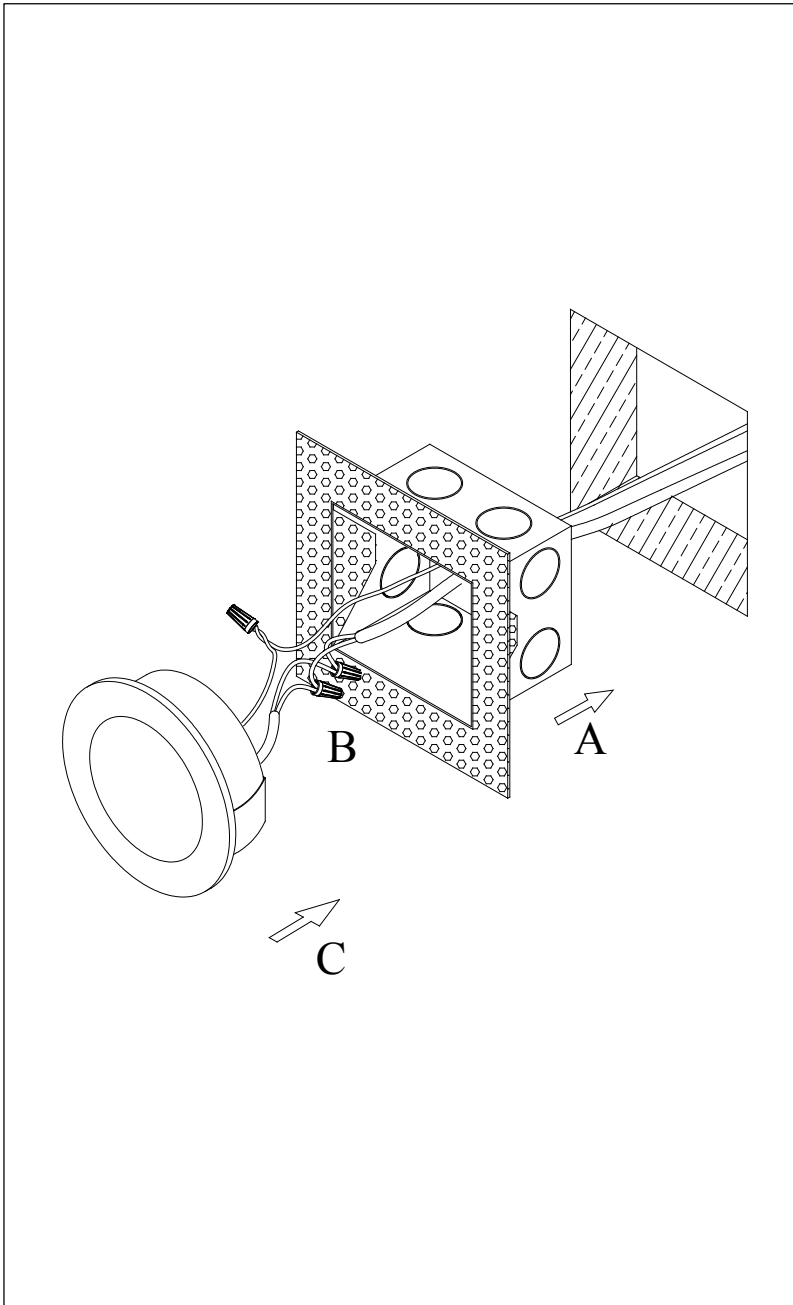

1.)

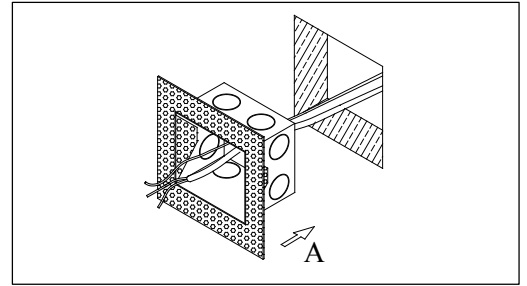

Step.1: Fix the Mounting box(B) to the hole.

2.)

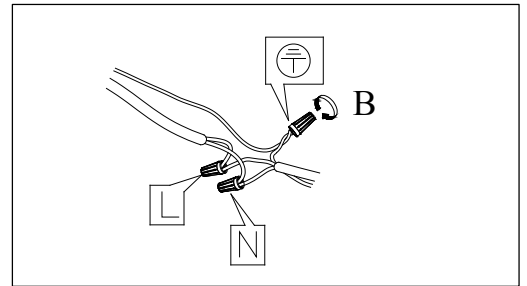

Step.2: Wire fixture to wires in outlet box.
Green/Copper wire is for Ground.

3.)

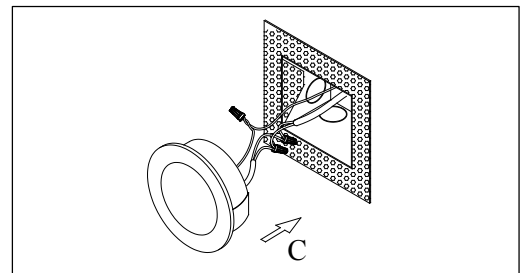

Step.3: Caulk around the housing with silicone sealant to prevent water intrusion. Leave a gap at the bottom to let moisture escape. Then install fixture to housing (C).

Cleaning & Care:

Clean with soft cloth and a mild detergent.
Do not use abrasive cleaner.