

1. Lay out glass by row beginning with bottom row 1. Glass is attached to cage by simply inserting hook onto horizontal bar and pull towards you until it locks.
2. Begin on bottom row 1, Space A and work counter clockwise until each row is complete. **Please note that enclosed diagram is a suggested layout. It is not critical to install exact. Glass size will vary so sometimes installing a piece on the next row down allows glass to stand more upright.**
3. Last are placed on vertical supports. It is not necessary to hook these to frame
4. Extra glass is supplied so if there is left over do not be concerned. If you can install extra on frame do so.

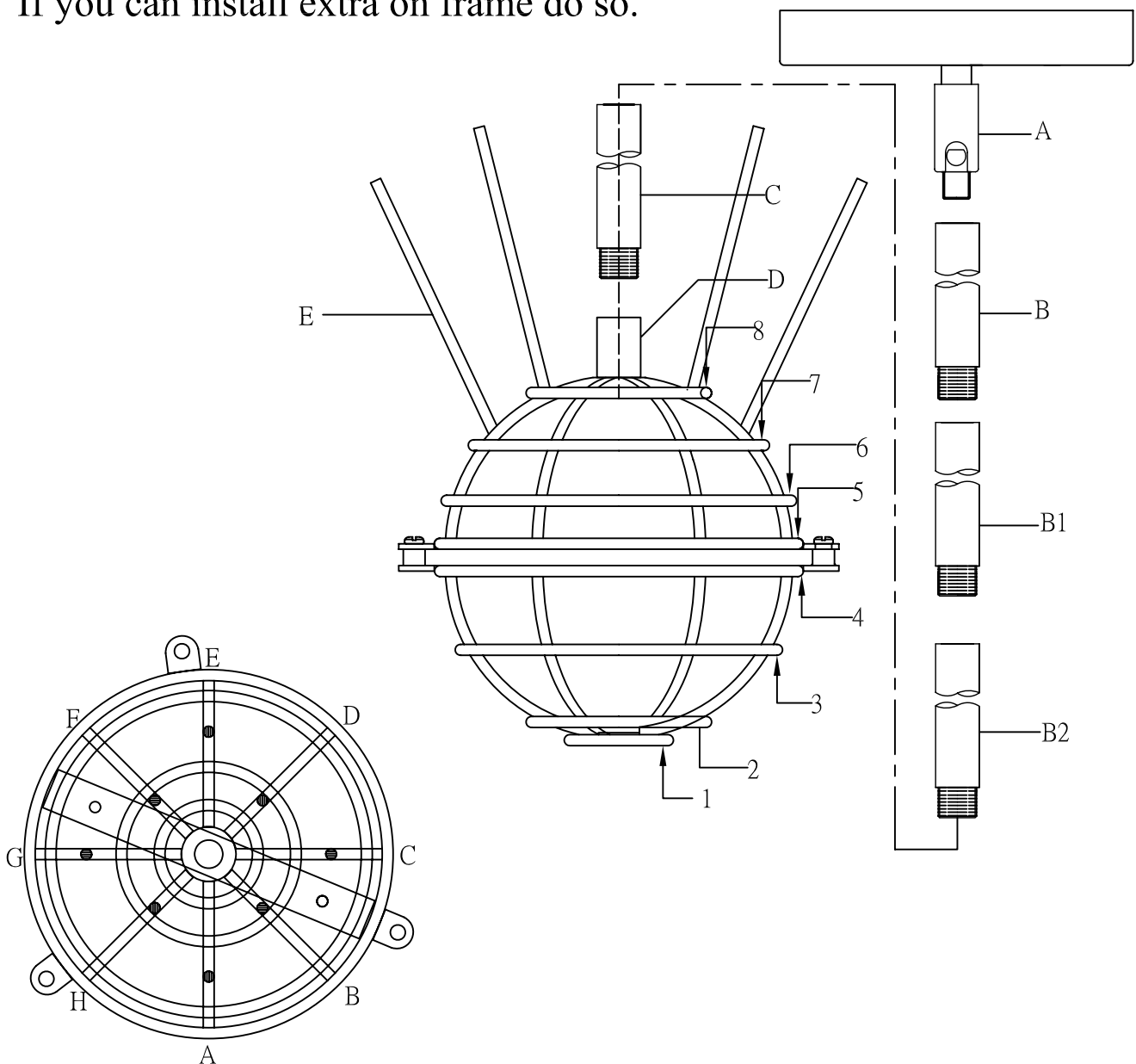

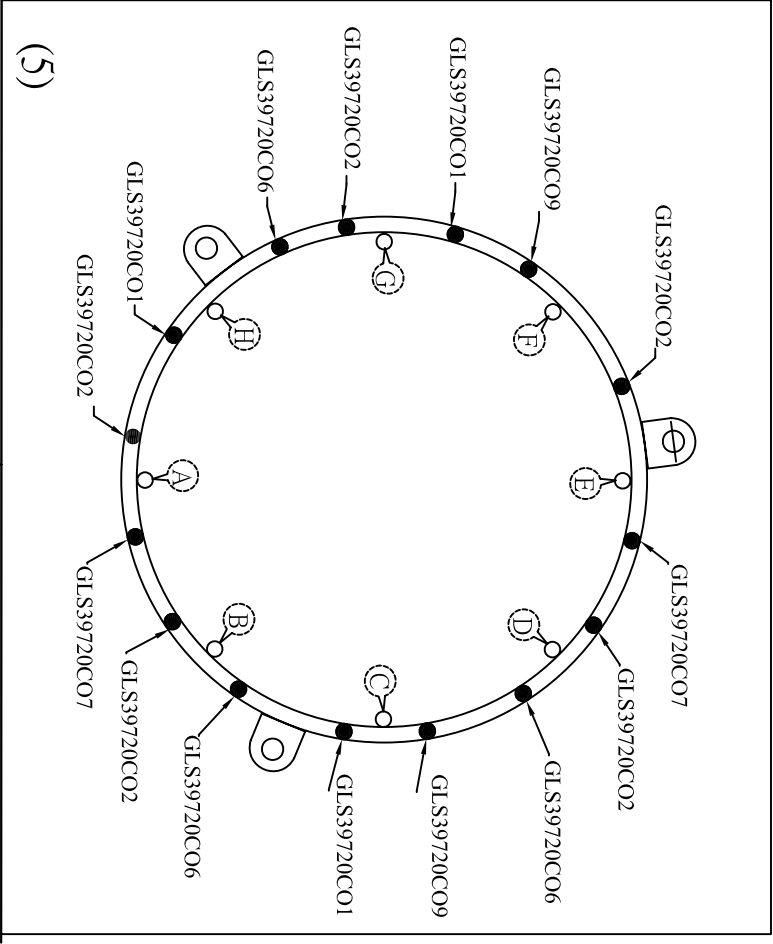

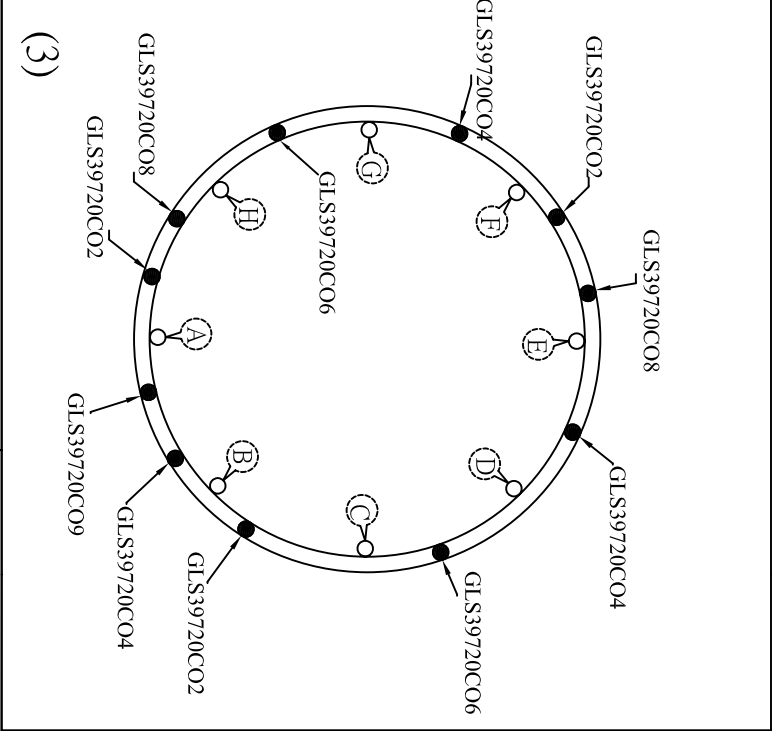
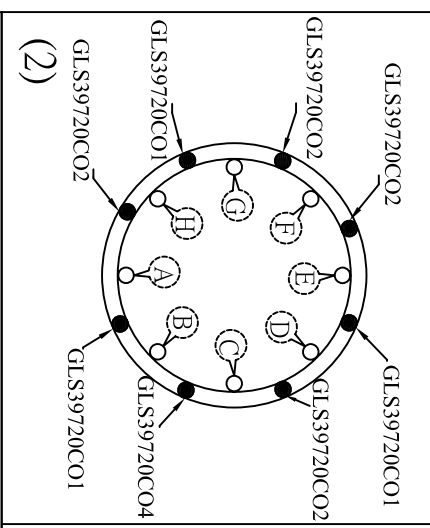
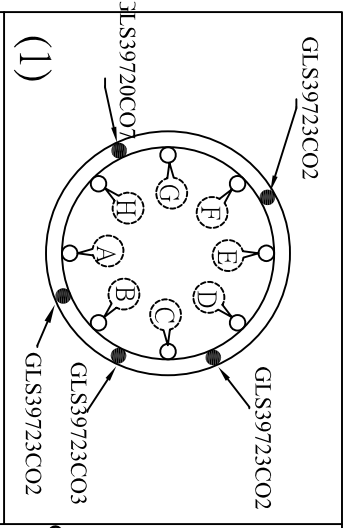
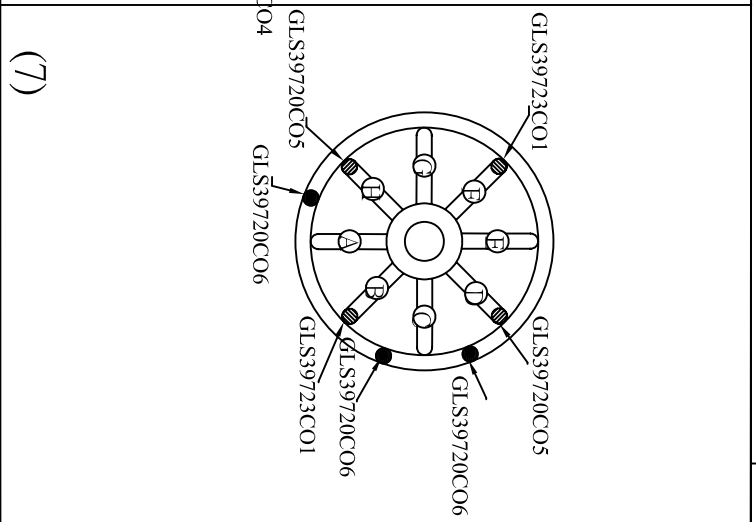
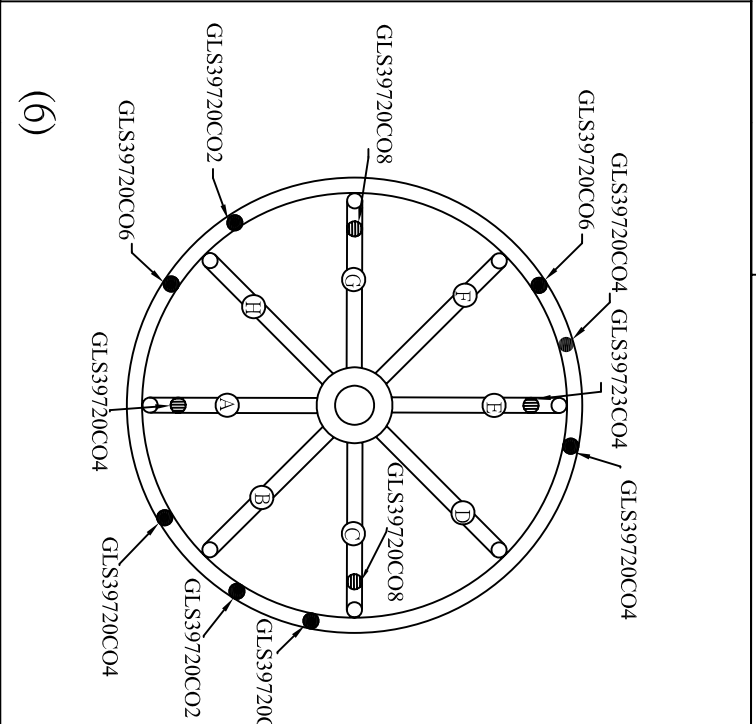
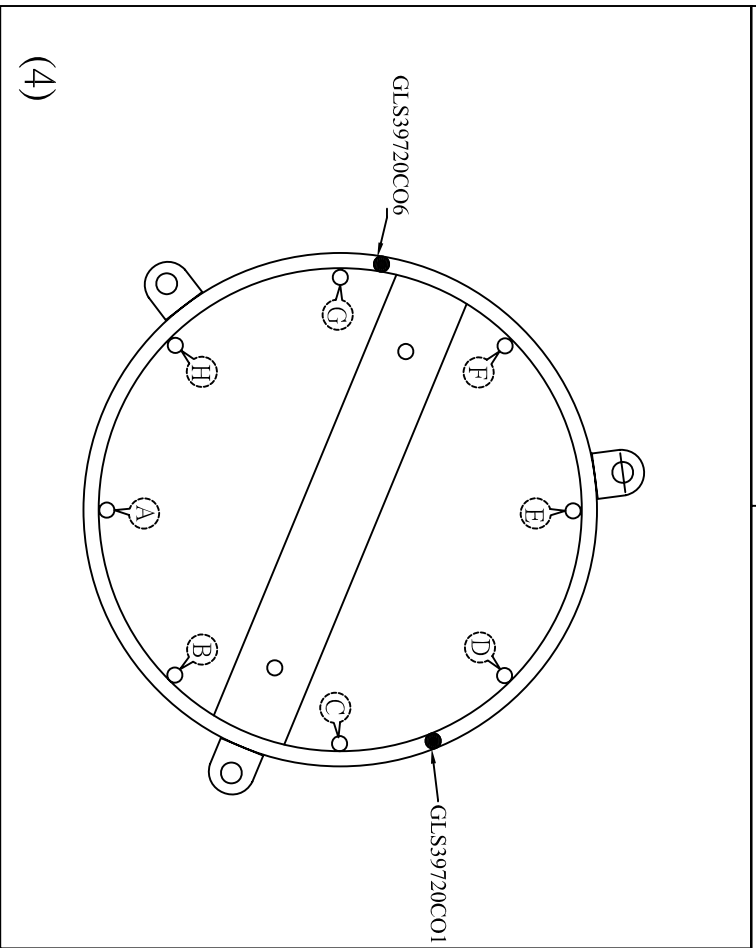

# CO=Cognac Finish

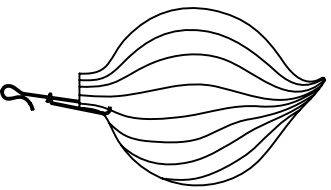

GLS39720CO2

Glass size: 3.75"W\*5.25"H

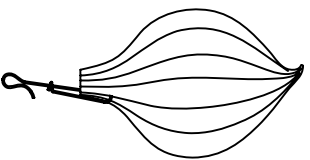

GLS39720CO1

Glass size: 3"W\*4.25"H

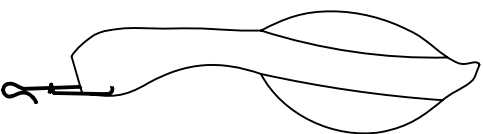

GLS39720CO7

Glass size: 1.5"W\*8.75"H



GLS39720CO8

Glass size: 1.5"W\*11.5"H

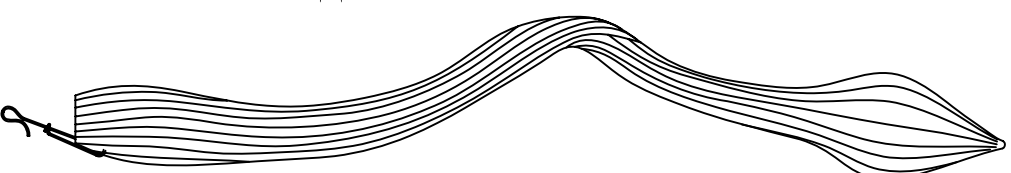

GLS39723CO3

Glass size: 1.5"W\*15.75"H

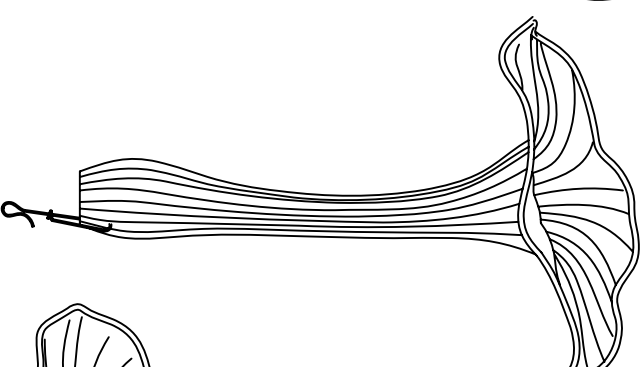

GLS39723CO4

Glass size: 1.5"W\*11.75"H

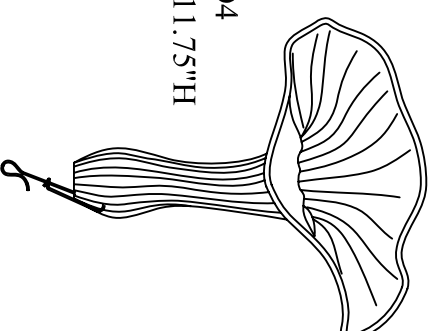

GLS39720CO9

Glass size: 1.5"W\*7.5"H

# CO=Cognac Finish

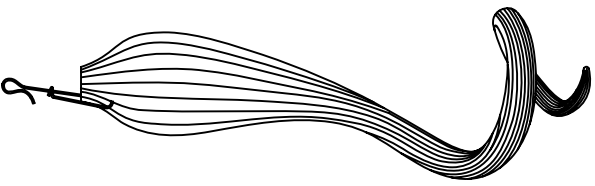

GLS39720CO4

Glass size: 2.5"W\*10.5"H

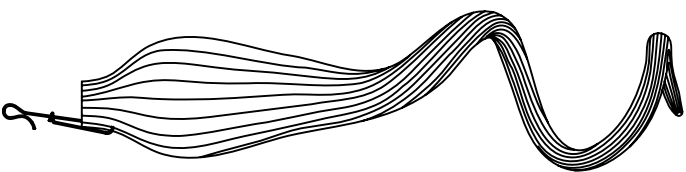

GLS39723CO1

Glass size: 2.5"W\*12.5"H

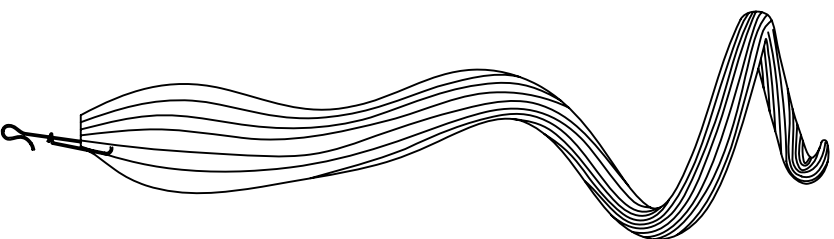

GLS39723CO2

Glass size: 2.5"W\*15.75"H

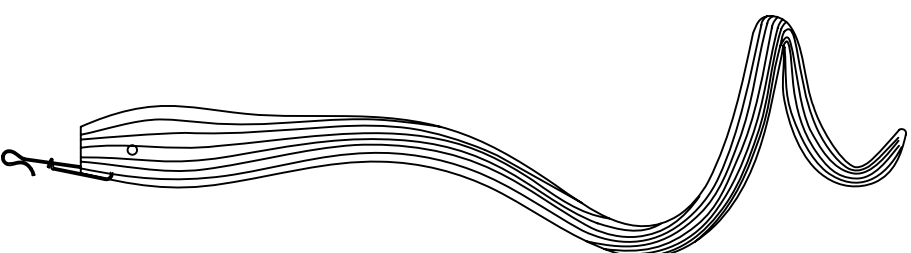

GLS39720CO5

Glass size: 1.5"W\*17.5H

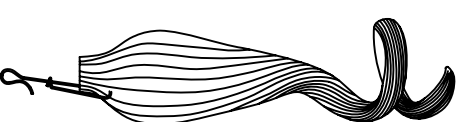

GLS39720CO6

Glass size: 2"W\*7.75"H